



POWEROPTIMAL  
THE FUTURE OF ENERGY



## PowerOptimal Elon® 100 Installation Manual

Version number: 2.27  
Version date: 2024/09/21  
Enquiries: [info@poweroptimal.com](mailto:info@poweroptimal.com)  
Address: Postnet Suite 21  
Private Bag X21  
Tyger Valley  
7536

Patented: GB2583814, ZA2019/02129, ZA2022/08516, EP 4100979

Patents pending: PCT/IB2021/050542, GB2206504.9



## SAFETY WARNING

- **Installation of the Elon® 100 should ONLY be performed by an electrical contractor registered with the Department of Labour** (the so-called “wireman’s licence”) and strictly according to the installation instructions in this manual. **The electrician should provide you with a supplementary Certificate of Compliance (CoC) once installation is completed.**
- We strongly recommend that you use a reputable and experienced solar photovoltaic (PV) system installer to install your solar PV modules.
- **Solar PV modules exposed to the sun are live** (i.e. will produce electricity) and can give an electric shock. Special care should be taken and only trained solar PV installers should install the modules.
- **Do not attempt to** alter or service the electrical installation, or open the Elon® 100 unit or controller for any purpose.
- Use the Elon® 100 **only for its intended purpose.**
- **Always** make sure that every wiring connection is **properly tightened.**
- **Do not earth** either of the solar module wires (but do earth the frames).
- All installation wiring should be at least 2.5mm<sup>2</sup>.
- Avoid coiling, since DC switching can create damaging spikes.
- Keep all wires as short as possible.

**Refer to the PowerOptimal website for the following:**

	<b>Elon® 100 User Manual</b>	<a href="http://www.poweroptimal.com/manuals">www.poweroptimal.com/manuals</a>
	<b>Training videos for electricians</b>	<a href="http://www.poweroptimal.com/elon-100-training">www.poweroptimal.com/elon-100-training</a>
	<b>Online User Instructions Video</b>	<a href="http://www.poweroptimal.com/elon100">www.poweroptimal.com/elon100</a>
	<b>Online Elon® Basic Training Course</b>	<a href="https://moolmaninstitute.com/p/elon-course">https://moolmaninstitute.com/p/elon-course</a>

## Table of Contents

Table of Contents.....	3
1. Required tools.....	4
2. Basic wiring diagram .....	5
3. Solar PV array installation .....	8
4. Elon® 100 installation.....	10
5. Element installation (retrofit) .....	16
Appendix A. Basic Troubleshooting Guide for Electricians .....	18
Appendix B. Solar yield .....	19
B1. Solar irradiance levels .....	19
B2. Geographic features .....	20
B3. Azimuth / horizontal angle .....	20
B4. Inclination or tilt angle.....	20
B5. Shading.....	20
B6. Ambient temperature.....	21
B7. Minimum distance from roof edges .....	21
Appendix C. Deciding on Size of Solar Array.....	22
Appendix D. PV array and geyser (water heater) element matching.....	28
Appendix E. Technical Specification Summary: Elon® 100 .....	29
Appendix F. Surge Protection Device (SPD) Recommendations.....	30
E1. SANS 10142-1 The wiring of premises Part 1: Low-voltage installations .....	30
E2. Draft standard SANS 10142-3 Proposed Interim Guideline for the wiring of LV grid-embedded PV installations not exceeding 1000kVA in South Africa.....	31
Appendix G. IEC/SANS and EMC Test Certificates: Elon® 100 .....	34
Appendix H. Warranty .....	38
Appendix I. Terminology .....	39
Notes.....	40

## 1. Required tools

The following tools are required for the installation. Use insulated tools wherever applicable.

- Solar modules (mounting) - *please refer to solar module / mounting installation instructions – the below is only a guideline:*
  - Cordless screwdriver with bits
  - Drill
  - Set of drill bits (wood, steel, stone)
  - Set of screwdrivers
  - Set of Allen (hex) keys
  - Tape measure
  - Grinder (tile roof installations)
  - Permanent marker
  - Chalk
  - Hammer
- Solar modules (electrical):
  - AC/DC Clamp meter
  - Side-cutting pliers
  - Screwdriver set
  - Crimping tool
  - 4 mm<sup>2</sup> wire (double insulated) (or other size as determined by solar PV voltage and wire length)
  - Cable ties
- Elon® 100 - *the following additional tools:*
  - 2.5 mm<sup>2</sup> panel wire

## 2. Basic wiring diagram

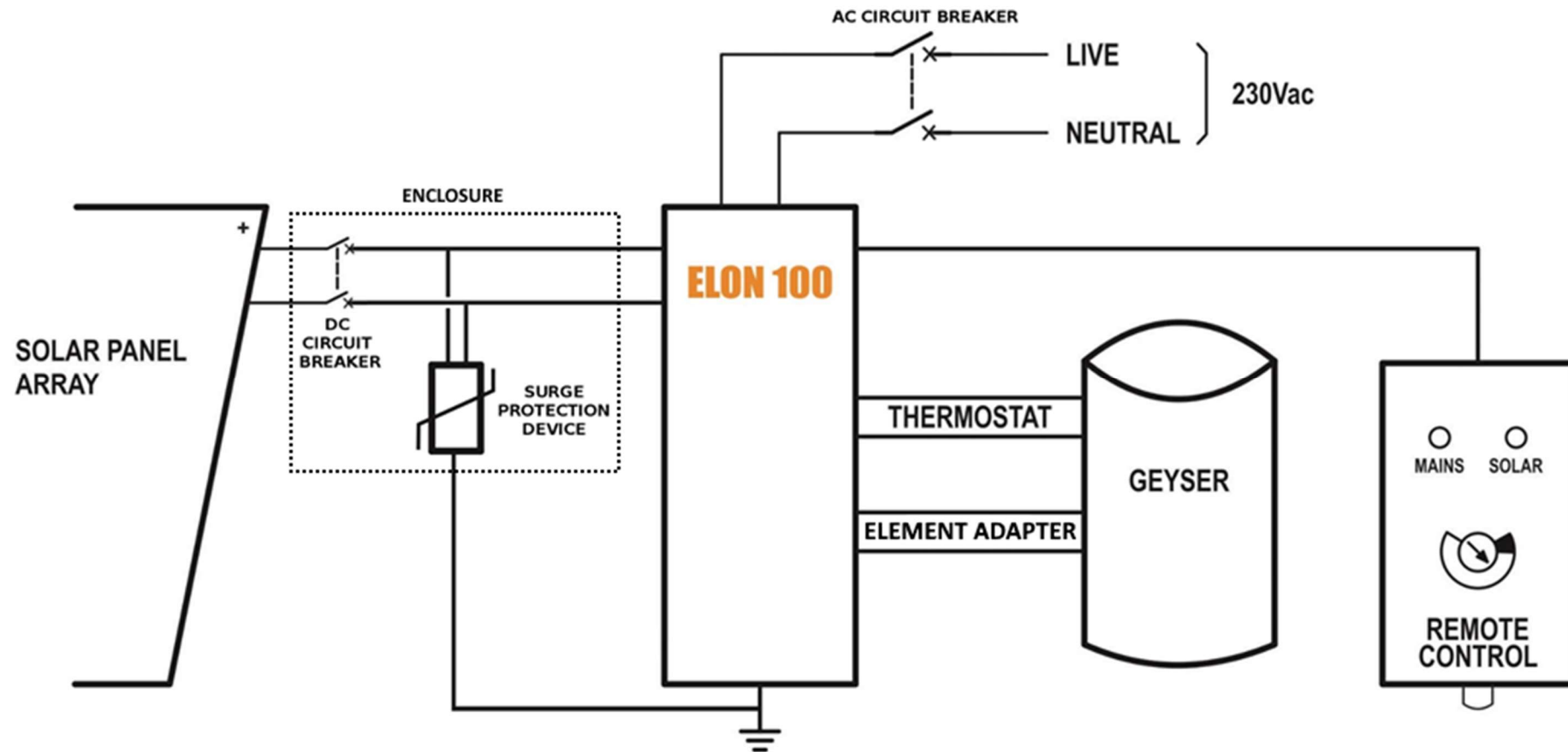

**Note 1:** Both AC & DC circuit breakers or isolators must be installed **within 1.5m of the geyser** (water heater), line of sight.

**Note 2: Surge Protection Device (SPD)** only required in higher lightning strike density areas (such as parts of Gauteng and Mpumalanga), or where the DC cables are long. See **Appendix F**.

**Wiring detail: Elon 100 with wiring kit**  
(see Figure 4.1)

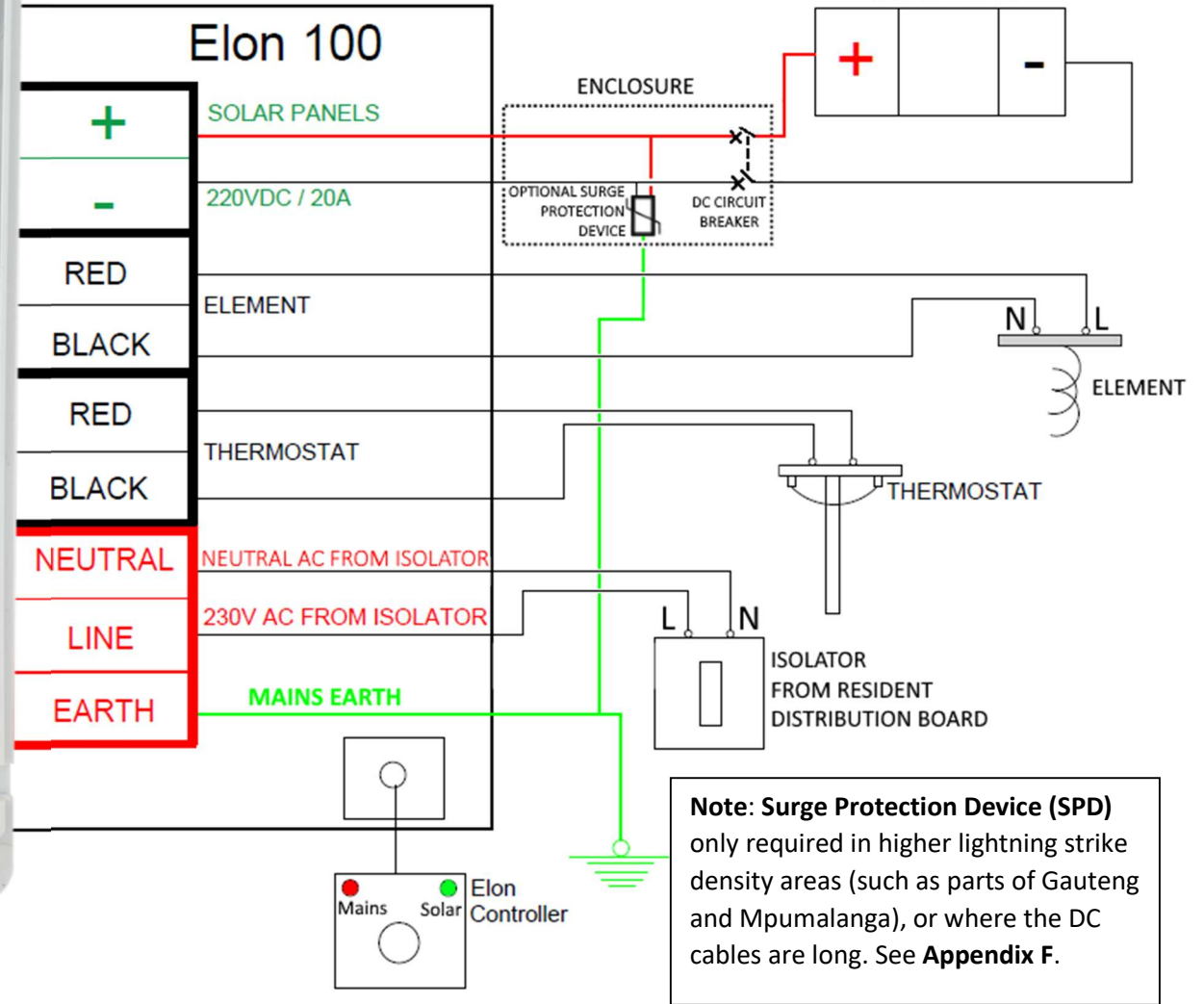

**Wiring detail: Elon 100 with element adapter**  
 (see Figure 4.2)

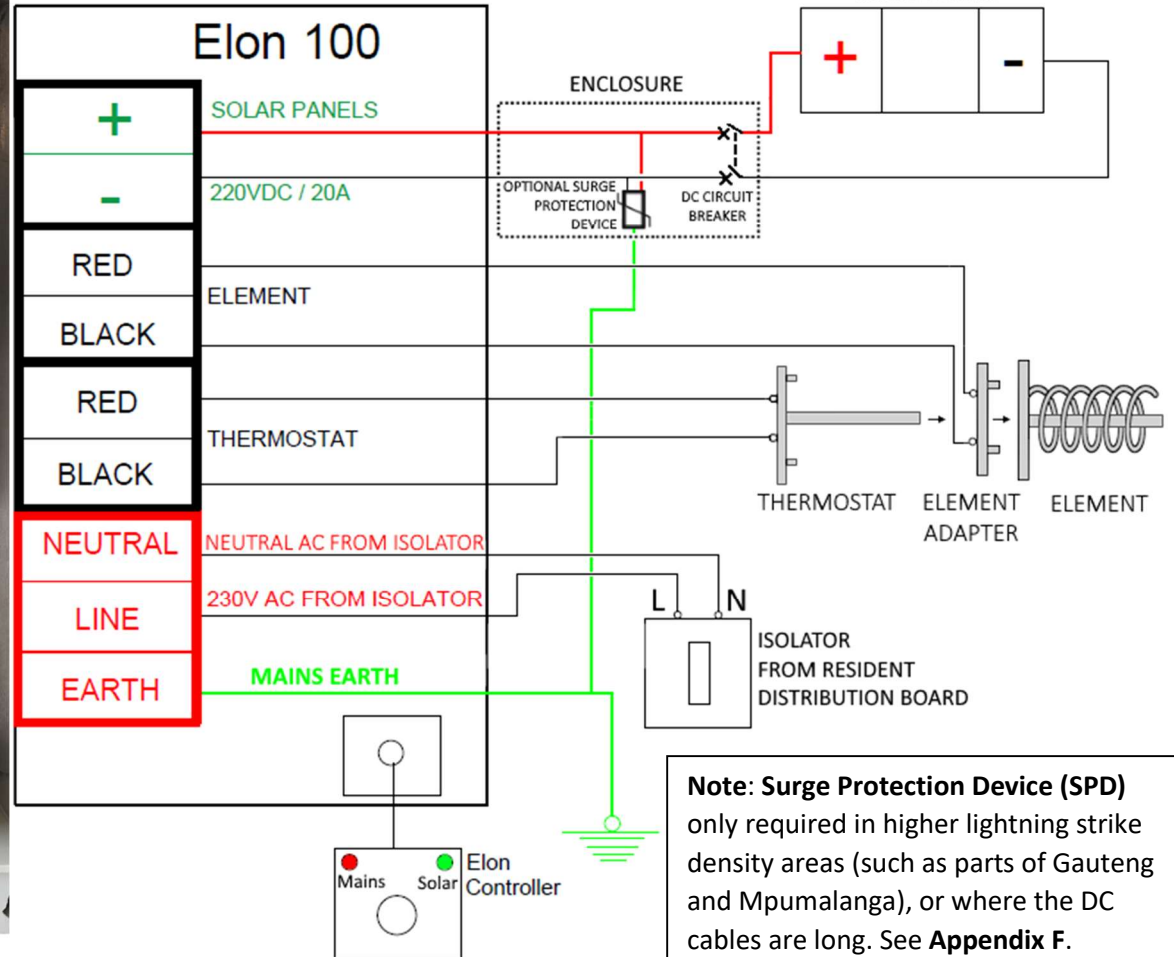

### 3. Solar PV array installation

Modules should only be installed by a **trained solar PV installation technician**. Array **position and orientation have a major impact on power production** (see Appendix B).

Review the instructions from your solar PV module supplier / manufacturer on installation.



**Please note:** Your installer should comply with SANS 10142-1 (Standard for low voltage installations) and SANS 60364-7-712 when doing your solar PV installation. If they are not well familiar with these standards, you should look for a different solar PV installer.

SAPVIA (South African Photovoltaic Industry Association) has made available an excellent guide to solar PV installations. See:

<https://www.pvgreencard.co.za/Solar%20PV%20Guidelines%20-%20Digital%20Spread%20High-res.pdf>

**NB: Refer to Appendices C & D for guidelines on selecting the right size solar PV array for the user requirements, and for correctly matching the solar PV array and the geyser element.**

The below installation steps are a **general guide only** – compliance with the abovementioned standards is **compulsory**.

1. A critical starting point is **safety gear**: ensure that all installers wear a helmet and insulated safety gloves, as well as fall protection safety gear if work will be done on a roof or elevated area.
2. The solar PV array should only consist of one string of 2 to 6 modules in series, or two parallel strings 2 to 5 modules each. **Do not exceed the DC voltage or current ratings of the Elon® 100 (240V DC and 20A DC) under any circumstances. Do not exceed the maximum power rating of 4 kW<sub>p</sub>.**
3. Attach bracket / mounting structure to roof. Use mounting structure recommended by solar module supplier for roof type and size of solar modules.
4. Fix the solar PV modules to the mounting structure whilst connecting the module cables to each other.
5. If practical, cover the modules to ensure that there is no potential for electric shock whilst installing the system.
6. Ground the mounting structure only.
7. Install the wiring from the solar PV array to the Elon® 100 unit in the ceiling space. Ensure circuit breakers / isolators are in the “Open” position. Installation of a Surge Protective Device (SPD) between the solar PV array and the Elon® 100 is required in high lightning strike areas, such as parts of Gauteng and Mpumalanga. See **Appendix F** for more information.
8. **Last step** is to connect the array to the rest of the wiring, making sure that both the positive and negative wires are fully isolated from ground and keeping circuit breakers / isolators in the “Open” position.



**Some “DO’s & DON’T’s” when installing solar PV arrays:**

*Your solar PV installer should not make any of these basic mistakes, but they are listed here just in case.*

1. DO earth the PV array structure.
2. DO isolate the wires from the PV array structure.
3. DON’T use different sizes, types or specifications of modules together in the same string or array.
4. DON’T install solar arrays where they will be partially shaded during any season of the year if it can be avoided at all.
5. DO install the arrays so that there is space for inspection or maintenance when needed.
6. DO use cabling of the correct size for your solar array.
7. DON’T install the solar array flush with your rooftop. Use struts / brackets that ensure an unrestricted **air gap of at least 40 mm** between the roof and the modules.
8. DON’T walk on the modules.
9. DO ensure that connectors are kept clean and away from water.
10. DON’T leave exposed modules in short circuit.
11. DO ensure that all connectors are securely fastened.
12. DON’T exceed the voltage ratings of any components.
13. DO properly route and secure all cables.
14. DON’T coil cables.

## 4. Elon® 100 installation

1. Isolate the geyser – switch off the geyser circuit breaker at the main electrical distribution board (DB) AND switch off the geyser isolator at the geyser.
2. Confirm with a multimeter that there is no voltage across the wires.
3. Install circuit breaker (or isolator and fuse) for solar PV (DC) supply. Also install AC supply isolator / circuit breaker if there is none. **NB** Ensure that the DC circuit breaker is rated for the DC voltage and current of the installed solar PV array.
4. The circuit breakers / isolators must be installed within 1.5m of the geyser AND must be line of sight / visible (i.e. do not install them at the back of the geyser).
5. The DC wires must not be earthed – i.e. they must be fully isolated from earth. Do NOT test with a Megger.
6. Keep the DC wires as short as possible.
7. Avoid any coils in DC wires.
8. Recommended wiring size is at least 2.5 mm<sup>2</sup>. Use **panel wire** for all connections to the Elon® 100.
9. Install the Elon® 100 unit according to wiring diagram (see Section 2).
  - a. Mount the Elon® 100 unit close to the geyser and protect from outside elements. The **maximum wire length** between Elon® 100 and geyser is **3 m**.
  - b. It is recommended to install the Elon® 100 oriented with wiring exiting downward to minimise the risk of water ingress. The enclosure is IP65, but the glands and wires represent a potential water ingress point if not installed correctly.
  - c. Mount the controller (remote control) inside or next to the main DB in the house or in another convenient and accessible location (for example the garage). Double-sided mounting tape and Genkem contact adhesive work well for most surfaces. When inserting the controller wire into the Elon® 100 unit, make sure the connector clicks into place.
  - d. Connect the Elon® 100 and thermostat **last**.

You will have been provided with either a **wiring kit** (Figure 4.1 - FOLLOW INSTRUCTIONS 9A) OR an **element adapter** (Figure 4.2 - FOLLOW INSTRUCTIONS 9B). See also the training videos on how to install either of these here: <https://www.poweroptimal.com/elon-100-training/>.



**Figure 4.1** Wiring kit for TSE & Thermowatt thermostats

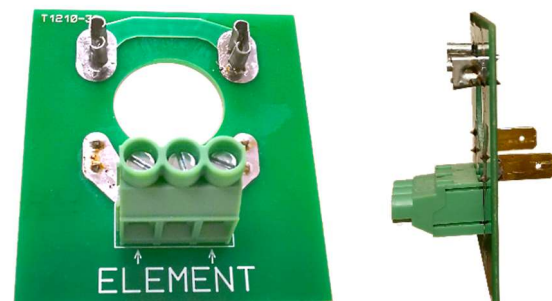

**Figure 4.2** Element adapter for TSE & Thermowatt thermostats (front & side view)

### 9A WIRING KIT INSTRUCTIONS (follow these if you have the wiring kit as per Figure 4.1)

**Note:** As per the wiring diagram, the thermostat and element should be connected to the Elon® SEPARATELY (independently).

- e. For TSE and Thermowatt (RTS) thermostats, connect the connectors marked “thermostat” on the Elon® directly to the two screw terminals on the thermostat and short the two male terminals at the bottom of the thermostat together, using the bridging wire with female connectors supplied with the Elon® 100 (Figures 4.3 and 4.4). (Less than 20 mA DC current will flow through this wire – it is a sensing current only.) There must be no connection between the thermostat and the element.



**Figure 4.3** Bridging wire for TSE & Thermowatt thermostats



**Figure 4.4** Bridging wire fitted to TSE Thermostat

- f. Connect the two element terminals directly to the connectors marked “element” on the Elon®. For flange-type elements, use the supplied wiring with element connector (Figures 4.5 and 4.6). **Make sure that the element connector fits tightly into the element and that the two male spade terminals of the connector are slotted correctly into the female terminals of the element.** Crimp both terminals (you can do this through the plastic cover) to ensure a tight fit on both sides.



**Figure 4.5** Element connector



**Figure 4.6** Element connector fitted to flange-type element

- g. Slide the thermostat (with bridging wire installed) into the thermostat pocket in the element as deep as it can go. (Slide it in rotated 180° from its normal orientation.)
- h. Continue with instructions from STEP 10.

**9B ELEMENT ADAPTER INSTRUCTIONS (follow these if you have the element adapter as per Figure 4.2)**

- d. Plug the thermostat into the element adapter as per Figure 4.7, ensuring a snug fit. Check that spade terminals enter female terminals correctly.



**Figure 4.7 Thermostat plugged into element adapter**



**Figure 4.8 Thermostat & element adapter plugged into element**

- e. Plug the thermostat + element adapter into the element as per Figure 4.8, ensuring a snug fit. Tug on each side to confirm correct fit.
- f. Wire the thermostat screw terminals directly to the connectors marked "Thermostat" on the Elon.
- g. Wire the element adapter directly to the connectors marked "Element" on the Elon.
- h. Continue with instructions from STEP 10.

10. Set the thermostat to the desired temperature (60 °C maximum). Note that vertically installed geysers have higher temperatures at the top than the bottom (this is called thermal stratification). The temperature difference is about 3 °C per meter. Reduce the setpoint temperature in vertically installed geysers to about 5 °C lower than for a horizontally installed geyser.

11. Attach labels included with the Elon 100 (see Figure 4.9 on next page):

- Attach "Dual Supply" labels to the AC isolator and the DC circuit breaker (or isolator).
- Attach "Warning – Photovoltaic Power Source" label to the DC wiring conduit in a clearly visible position.
- Attach "Installation Diagram" label close by the geyser in a clearly visible position – for example on a rafter. (**Do not attach it directly to the geyser**, as it will disappear if the geyser is replaced.)

12. Once installation is complete, do the following:

- Turn the control dial to "SOLAR ONLY".
- Switch on the AC & DC circuit breakers or isolators.
- Remove the covering from the solar modules.
- Switch on the geyser circuit breaker at the main DB.

13. Check that the Elon® 100 unit is operational (refer to LED lights on controller – see next page).

- a. Confirm solar PV array supply voltage and DC power to geyser when thermostat is closed. The Elon® 100 will switch DC power to the geyser approximately 10 to 15 seconds after DC power to the Elon® has been switched on (if there is enough sunlight). (If thermostat is not closed, open hot water tap in house until thermostat closes.)
  - b. Test mains power supply by turning the dial to "MAINS ONLY". The red light should start flashing (except if geyser is already at thermostat setpoint temperature). **NOTE THAT THE ELON® WILL ONLY SWITCH TO MAINS 5 MINUTES AFTER MAINS POWER SWITCH-ON OR RECONNECTION.** This is to allow grid power to stabilize after a power failure.
  - c. Confirm that no power is supplied to geyser element when thermostat is open (turn thermostat set point to lowest setting).
  - d. Set thermostat back at desired temperature (**60 °C maximum**).
14. Set control dial to setting "2" (the 6 o' clock position). (For new property development installations, you can set the control dial to setting "1" (the 9 o'clock position). This ensures that new residents can settle in before deciding on the setting that suits their habits best.)



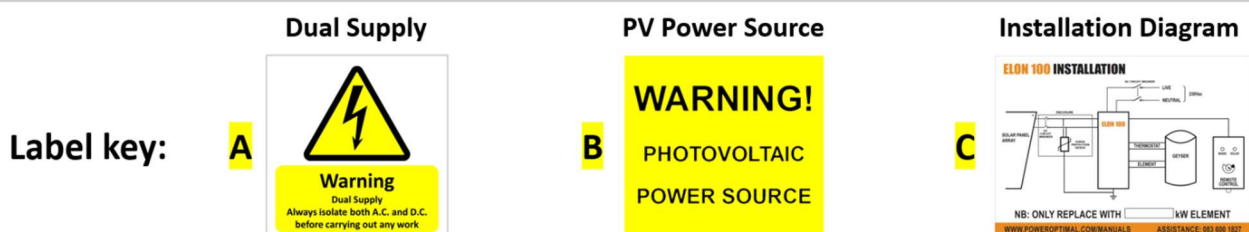
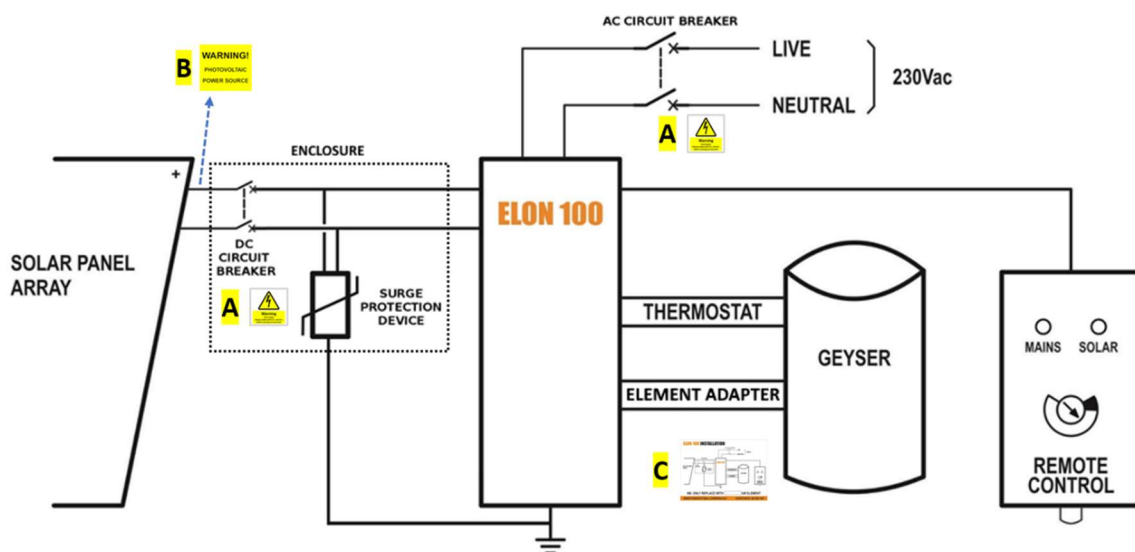



**Note:** if doing any maintenance, rewiring or disconnecting the Elon® 100 or geyser element for any reason, it is good practice to **first switch off both the AC & DC circuit breakers / isolators, and then disconnect one of the wires between the Elon® 100 and thermostat before disconnecting the rest of the wires.**

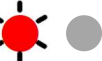

**Figure 4.9 Label positions (see step 10 on previous page)**

**Please note:** DO NOT install a separate timer on the AC side to try and regulate mains power use. Use only the Elon's control dial to control mains power use. If you install a second timer, it will work at cross-purposes with the Elon and you will reduce performance and hot water availability.

The **Mains & Solar indicator lights** indicate the following conditions:

Lights	Meaning
	<b>Green light ON</b> Geyser on temperature
	<b>Green light flashing</b> Heating with solar
	<b>Red light ON</b> Mains power available (mains power to Elon® unit on)
	<b>Red light flashing</b> Heating with mains
	<b>Both lights ON</b> Geyser is on temperature. Mains power available (mains power to Elon® unit on)
	<b>Red light ON &amp; Green light flashing</b> Heating with solar. Mains power available (mains power to Elon® unit on)
	<b>Red &amp; Green light flashing fast</b> Isolation fault (contact electrician)
	<b>Both lights OFF</b> No power to unit (for example: no sun plus a power failure, or no sun plus geyser breaker at DB board is switched off) OR supply voltage outside specifications



The **control dial** sets the mains & solar times as follows:

Dial Setting	Time on Mains*	Time on Solar*	24-Hour Clock
<b>MAINS ONLY</b>	24 hr	Never	
<b>1</b>	12:00 to 08:00	08:00 to 12:00	
<b>2</b>	14:30 to 05:30	05:30 to 14:30	
<b>3</b>	17:00 to 03:00	03:00 to 17:00	
<b>SOLAR ONLY</b>	Never	24 hr	



\* Times are approximate – will vary slightly with season and location



## 5. Element installation (retrofit)

If you need to exchange the element on an existing geyser, please follow the instructions provided by the element supplier.

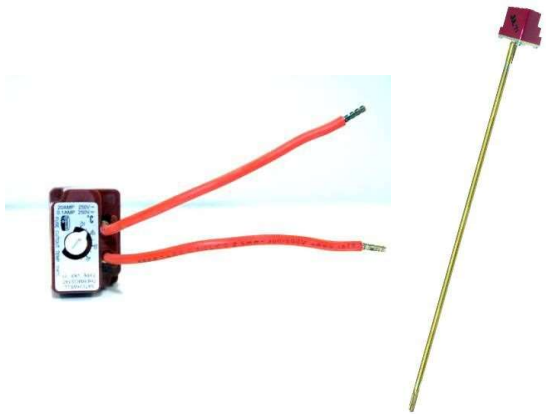
There are two main types of geyser **heating elements**: **screw-in** and **flange type**. There are three main types of **thermostats**: **VKF-11**, **TSE** and **Thermowatt** (the TSE and Thermowatt thermostats are quite similar). The below table provides a guide to Elon® compatibility with the different elements and thermostats.

Element type	Compatible thermostat type	Comments
<p>Screw-in element:</p> 	<p>VKF-11 thermostat:</p> 	<p>Element &amp; thermostat have separate electrical connections, so each can be connected (wired) separately to the Elon®. Thus, <b>this element-thermostat combination is directly compatible with the Elon®</b>. (No need to use the bridging wire or element adapter supplied with the Elon® unit.)</p> <p>The thermostat pocket in the element is the right size for the VKF-11 thermostat.</p> <p><b>Do not connect the thermostat in line with the element. Connect the two thermostat wires to the two terminals marked “thermostat” on the Elon 100 unit. Connect the element separately to the two terminals marked “element” on the Elon 100 unit.</b></p>

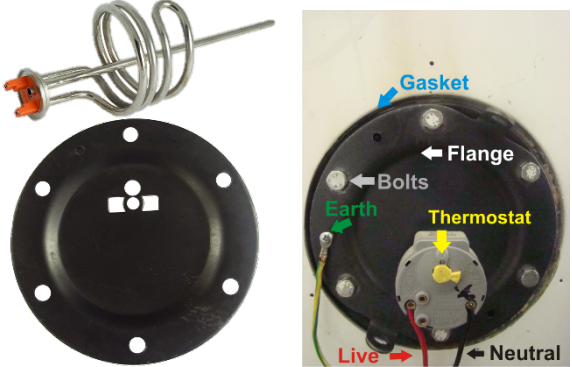

Element type	Compatible thermostat type	Comments
<p>Spiral element (flange type) with smaller diameter thermostat pocket:</p> 	<p>TSE thermostat: Thermowatt (RTS) thermostat:</p> 	<p>The spiral element generally has a smaller thermostat pocket than the screw-in element. The TSE and Thermowatt (RTS) thermostats fit into this smaller pocket. The VKF-11 thermostat requires a larger pocket and does not fit into standard spiral element pockets.</p> <p>The TSE and Thermowatt thermostats normally clip directly into the element, but this won't be the case when the Elon® is connected.</p> <p><b>Use the wiring kit or element adapter supplied with the Elon® (see Figures 4.1 and 4.2 above) to connect the Elon® to these thermostats and elements.</b></p>

## Appendix A. Basic Troubleshooting Guide for Electricians

**NOTE:** This Troubleshooting Guide is intended for electricians and not general users. Users should please refer to the User Manual, which can be found at [www.poweroptimal.com/manuals](http://www.poweroptimal.com/manuals).

### Things to Remember

- The **red mains LED** will only start functioning once stable mains voltage between 190 and 260 V AC is present for more than **5 minutes**. (In other words, the Elon® will only allow mains power to the element 5 minutes after mains connection or switch-on.)
- **Solar power** is only recognised **40 seconds** after active solar panels are connected to Elon®.
- An **open thermostat** (water at correct temperature) measures between **11 and 14 V DC** across the “thermostat” terminals on the Elon®. Polarity across these terminals is not important.
- A **closed thermostat** (cold water) measures **0 V** across the “thermostat” terminals on the Elon®.
- **How to switch on solar power to element:** With enough solar energy (check at solar terminals), solar power will be routed to the element within 15 seconds after the thermostat closes and the controller dial is set to “**SOLAR ONLY**”. A green flashing LED indicates this condition.
- **How to switch on mains power to element:** Turn control dial to “**MAINS ONLY**” and, if the thermostat is closed, mains power will be directed to the element indicated by a red flashing LED.
- **Note:** Once the dial has been turned to “**MAINS ONLY**”, it will complete a full mains heating cycle (until the thermostat opens). Turning the control back to “**SOLAR ONLY**” at this point will not immediately switch the unit back to solar power. It will only switch back again after the mains heating cycle is completed (i.e. the thermostat opens) and the thermostat then closes again. You can finish the mains heating cycle faster by reducing the thermostat temperature setting until the thermostat opens. **Test solar power first.**
- Fast flashing red / green LEDs indicate a short between a PV (photovoltaic) lead and earth – this condition prevents solar power to the element.

### Troubleshooting Steps

- 1)  Confirm correct wiring and polarity to Elon®. Also confirm test meter wires are connected correctly, black to common!
- 2)  Confirm correct voltages and currents of all connections through the following steps:
  - Confirm open / closed **thermostat** voltages (11 – 14 V DC open, 0 V DC closed).
  - Confirm **controller wire** is connected properly. The connections should “click” into place and appropriate LEDs should indicate (be active).
  - With solar power to element switched on (green LED flashing), confirm same **DC voltage to element** as measured at solar terminals.
  - With **DC clamp meter** confirm that there is an **active current through element**.
  - With mains power to element switched on (red LED flashing), confirm same **AC voltage to element** as measured at mains terminals (should be approx. 230V AC).
  - With **AC clamp meter** confirm **active current through element** of between 9 and 18 Amps depending on element rating.
- 3)  If you used a test controller for troubleshooting, remember to plug the wire from the installed controller back into the Elon® and check functioning. Set thermostat back to original setting.

## Appendix B. Solar yield

**Note:** only basic information is provided here. Your solar PV installation design engineer or technician should advise on the best configuration for your specific location, roof structure, etc.

The yield produced by solar PV modules depends on several factors:

- Solar irradiance levels at your location (which varies with time of day, season and weather conditions)
- Geographic features at your location (e.g. mountains or buildings causing morning or afternoon shade)
- Azimuth and tilt of the modules
- Shading
- Ambient temperature (also influenced by wind)

### B1. Solar irradiance levels

The map below shows the general solar irradiance levels (GHI or Global Horizontal Irradiance) in South Africa<sup>1</sup>:

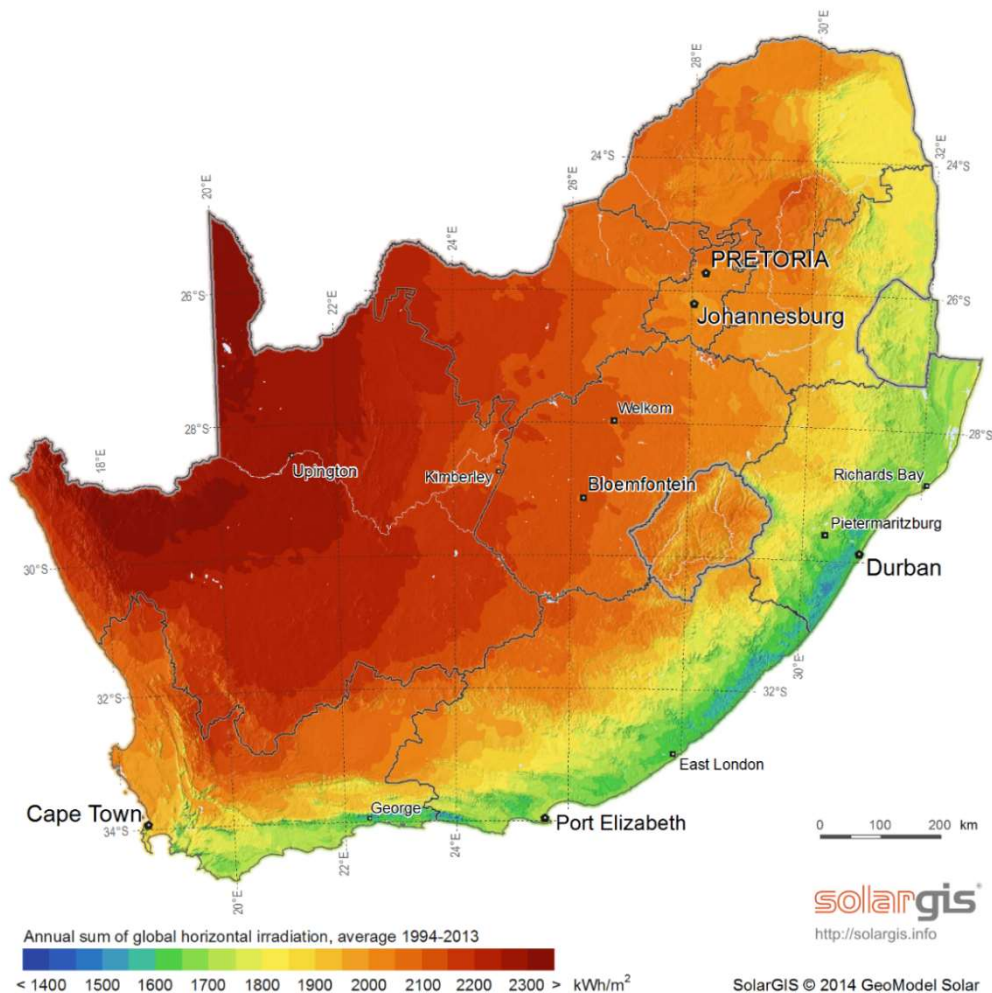

<sup>1</sup> CRSES (Centre for Renewable and Sustainable Energy Studies). Website: [http://www.crses.sun.ac.za/files/research/publications/SolarGIS\\_GHI\\_South\\_Africa\\_width15cm\\_300dpi.png](http://www.crses.sun.ac.za/files/research/publications/SolarGIS_GHI_South_Africa_width15cm_300dpi.png). Last accessed: 07/04/2017.

You can expect the following approximate energy generation from solar modules for various locations<sup>2</sup>:

Location	Electricity generated kWh/kWp per year
Bloemfontein	2055
Cape Town	1762
Durban	1570
Johannesburg / Pretoria	1871
Mbombela	1766
Port Elizabeth	1698
Upington	2075

## B2. Geographic features

Major geographical features (such as hills or mountains) can reduce the total solar yield.

## B3. Azimuth / horizontal angle

The **azimuth** refers to the horizontal orientation of the modules – in the Southern Hemisphere, by how many degrees they are oriented away from north

**Due north is best** in the Southern hemisphere. Modules should preferably not be oriented more than 15° away from due north.

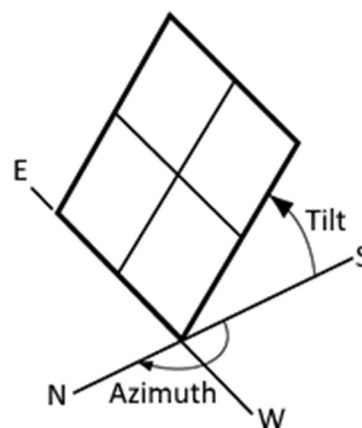

## B4. Inclination or tilt angle

The **tilt angle** refers to the vertical orientation of the modules – a rough guide is that the modules should be tilted at the site's latitude. For example, Musina is 22° S, Pretoria & Johannesburg are 26° S, Bloemfontein is 29° S, Durban is 30° S and Cape Town & Port Elizabeth are 34° S.

To optimise winter performance, one can add 15° to the tilt angle. (**Note:** as long as you are within about 15° of the optimal latitude, the loss in efficiency is not substantial.)

## B5. Shading

Solar modules lose a lot of efficiency if even a small part of the module is shaded. For example, just 3% shading can cause a 25% loss in power! Shaded cells on a module also causes hotspots, which will reduce module lifetime.

It is thus **important** to place the solar modules on a rooftop area that is **free from shading** for as much as possible of the day (and throughout the year).

---

<sup>2</sup> Urban Energy Support. Website: [http://www.cityenergy.org.za/uploads/resource\\_274.pdf](http://www.cityenergy.org.za/uploads/resource_274.pdf). Last accessed: 07/04/2017.

## **B6. Ambient temperature**

Solar PV modules' performance decreases with increasing temperature. Wind will reduce the temperature of the solar array and will thus improve performance. Thus, it is important to install rooftop solar modules with an air gap of at least 40 mm between the modules and roof<sup>3</sup>.

## **B7. Minimum distance from roof edges**

Your solar PV design engineer should prescribe minimum clearance from roof edges that should be maintained for your area based on climatic and wind conditions. Typically, a minimum clearance of 20 to 30 cm should be maintained.

---

<sup>3</sup> D'Orazio M *et al.* 2013. Performance assessment of different roof integrated photovoltaic modules under Mediterranean Climate.

## Appendix C. Deciding on Size of Solar Array

### Terminology used

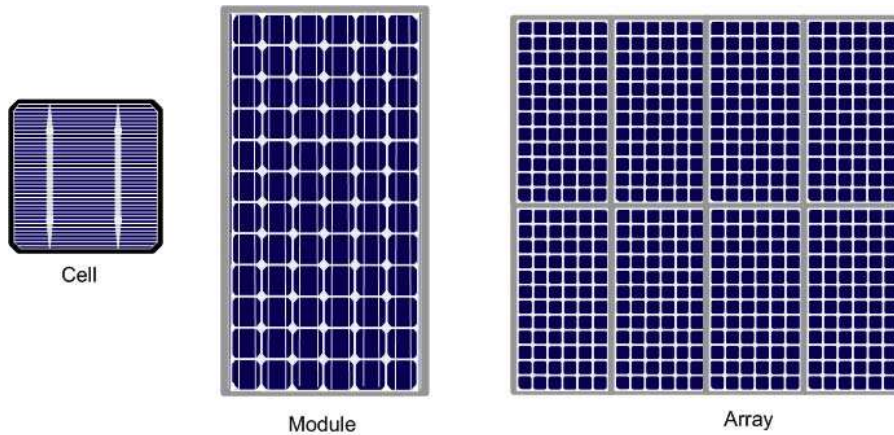

Solar power is generated by solar **cells**, which are arranged in framed **modules**, typically of 60 or 72 cells each. The total set of solar PV modules installed is referred to as a solar PV **array**<sup>4</sup>.

The table below provides a basic guide to selecting the size of the solar PV array based on number of people in the household and/or hot water use. Minimum recommended size is 1 kW<sub>p</sub>. Read on for a more detailed guide.

Solar PV array size (kW <sub>p</sub> )	Showers per day*	50%+ of daily hot water use provided for how many people?	How many people off-grid for hot water?	Typical number of solar PV modules
1 – 1.2				2 - 3 modules
1.2 – 1.6				3 - 4 modules
1.5 – 2				4 - 5 modules
2.4 – 3.2 (two parallel PV strings)				6 - 8 modules
3 – 4 (two parallel PV strings)				8 - 10 modules

\* 6-minute showers at 40 °C with 8 litre/min (low-flow) showerheads

<sup>4</sup> Image source: <http://ohioline.osu.edu/factsheet/AEX-652-11>.

**TABLE C1. ANNUAL AVERAGE LITRES OF WATER HEATED PER DAY**

The below example table indicates the average number of litres of water per day that the system will heat from 15 to 60 °C over a year period for different solar array peak power ratings. (The amount of water heated will vary with weather conditions, by geographic location and by season. Water heated per day will be significantly lower in winter and significantly higher in summer. These numbers indicate heating capacity – i.e. if no hot water is used on a given day, there will be less water heated on that day. This is only an **approximate** guide.)

Location	Solar + Elon® kWh/kW <sub>p</sub> /yr	Annual average litres of water heated per day for X kW <sub>p</sub> installed solar capacity									
		0.8 kW <sub>p</sub>	1 kW <sub>p</sub>	1.2 kW <sub>p</sub>	1.4 kW <sub>p</sub>	1.6 kW <sub>p</sub>	1.8 kW <sub>p</sub>	2 kW <sub>p</sub>	2.5 kW <sub>p</sub>	3 kW <sub>p</sub>	3.5 kW <sub>p</sub>
Bloemfontein	1894	80	99	119	139	159	179	199	249	298	348
Cape Town	1624	68	85	102	119	136	154	171	213	256	299
Durban	1447	61	76	91	106	122	137	152	190	228	266
Jhb/Pretoria	1724	72	91	109	127	145	163	181	226	272	317
Mbombela	1627	68	85	103	120	137	154	171	214	256	299
Port Elizabeth	1565	66	82	99	115	132	148	164	205	247	288
Upington	1912	80	100	121	141	161	181	201	251	301	352
Saldanha	1623	68	85	102	119	136	153	170	213	256	298

**Example:**

For a solar array of 1.2 kW<sub>p</sub>, an installation in **Johannesburg** would yield about 1724 kWh/kW<sub>p</sub>/yr, or 1724 x 1.2 kW<sub>p</sub> = **2069 kWh/yr**. This would be sufficient to heat on average **109 litres of water per day**. For a family of 2 each using 80 litres of hot water per day, this would provide about 109 ÷ (80 x 2) or **68% of the annual hot water requirement**.

**TABLE C2. ANNUAL AVERAGE NUMBER OF SHOWERS PER DAY**

The below table indicates the average number of showers per day for which the system will supply hot water over a year period for different solar array peak power ratings. (The amount of water heated will vary with weather conditions, by geographic location and by season. Water heated per day will be significantly lower in winter and significantly higher in summer. These numbers indicate heating capacity – i.e. if no hot water is used on a given day, there will be less water heated on that day. This is only an approximate guide.)

Location	Solar + Elon® kWh/kW <sub>p</sub> /yr	Number of showers per day (based on annual average) for X kW <sub>p</sub> installed solar capacity									
		0.8 kW <sub>p</sub>	1 kW <sub>p</sub>	1.2 kW <sub>p</sub>	1.4 kW <sub>p</sub>	1.6 kW <sub>p</sub>	1.8 kW <sub>p</sub>	2 kW <sub>p</sub>	2.5 kW <sub>p</sub>	3 kW <sub>p</sub>	3.5 kW <sub>p</sub>
Bloemfontein	1894	2.4	3.0	3.6	4.2	4.8	5.4	6.0	7.5	9.0	10.4
Cape Town	1624	2.0	2.6	3.1	3.6	4.1	4.6	5.1	6.4	7.7	9.0
Durban	1447	1.8	2.3	2.7	3.2	3.6	4.1	4.6	5.7	6.8	8.0
Jhb/Pretoria	1724	2.2	2.7	3.3	3.8	4.3	4.9	5.4	6.8	8.2	9.5
Mbombela	1627	2.1	2.6	3.1	3.6	4.1	4.6	5.1	6.4	7.7	9.0
Port Elizabeth	1565	2.0	2.5	3.0	3.5	3.9	4.4	4.9	6.2	7.4	8.6
Upington	1912	2.4	3.0	3.6	4.2	4.8	5.4	6.0	7.5	9.0	10.5
Saldanha	1623	2.0	2.6	3.1	3.6	4.1	4.6	5.1	6.4	7.7	9.0

The table is based on **6-minute** showers at **40 °C** and **8 litres/min** low flow showerheads. Old showerheads can use up to 15 litres/min and would substantially reduce the number of showers.

**Example:**

For a solar PV array of **2.5 kW<sub>p</sub>**, an installation in Johannesburg would yield about 1724 kWh/kW<sub>p</sub>/yr, or 1724 x 2.5 kW<sub>p</sub> = **4 310 kWh/yr**. This would be sufficient for about **6 to 7 showers per day**.



**TABLE C3. PERCENTAGE OF ANNUAL HOT WATER REQUIREMENT**

The below example table indicates what % of the annual hot water requirement will on average be supplied by the system for **2 people each using 80 litres of hot (60 °C) water per day**. (The amount of water heated will vary with weather conditions, by geographic location and by season. Water heated per day will be significantly lower in winter and significantly higher in summer. These numbers indicate heating capacity – i.e. if no hot water is used on a given day, there will be less water heated on that day. This is only an **approximate** guide.)

Location	Solar + Elon® kWh/kW <sub>p</sub> /yr	Annual average % of hot water requirement supplied for 2 people each using 80 litres of hot water per day for X kW <sub>p</sub> installed solar capacity									
		0.8 kW <sub>p</sub>	1 kW <sub>p</sub>	1.2 kW <sub>p</sub>	1.4 kW <sub>p</sub>	1.6 kW <sub>p</sub>	1.8 kW <sub>p</sub>	2 kW <sub>p</sub>	2.5 kW <sub>p</sub>	3 kW <sub>p</sub>	3.5 kW <sub>p</sub>
Bloemfontein	1894	50%	62%	75%	87%	99%	112%	124%	155%	187%	218%
Cape Town	1624	43%	53%	64%	75%	85%	96%	107%	133%	160%	187%
Durban	1447	38%	47%	57%	66%	76%	85%	95%	119%	142%	166%
Jhb/Pretoria	1724	45%	57%	68%	79%	91%	102%	113%	142%	170%	198%
Nelspruit	1627	43%	53%	64%	75%	85%	96%	107%	134%	160%	187%
Port Elizabeth	1565	41%	51%	62%	72%	82%	92%	103%	128%	154%	180%
Upington	1912	50%	63%	75%	88%	100%	113%	126%	157%	188%	220%
Saldanha	1623	43%	53%	64%	75%	85%	96%	107%	133%	160%	186%

**Examples:**

An array of **1.2 kW<sub>p</sub>** will provide approximately **64%** of the annual hot water requirement for a family of **two people in Cape Town**.

An array of **2 kW<sub>p</sub>** will provide approximately  $124\% \times (2 \text{ people} / 4 \text{ people}) = \mathbf{62\%}$  of the annual hot water requirement for a family of **four people in Bloemfontein**.

**TABLE C4. PEAK POWER OUTPUT FOR VARIOUS SOLAR MODULES AND ARRAY SIZES**

The peak power production ( $W_p$ ) of the modules at STC (Standard Test Conditions) and at NOCT (Nominal Operating Cell Temperature) are provided by the solar PV module manufacturer. The below table indicates the peak power at STC for a range of solar module power ratings and array sizes.

No. of cells per module	Module STC power rating ( $W_p$ )	Total peak power at STC in $kW_p$ for an array of X modules						
		3 modules	4 modules	5 modules	6 modules	8 (2 x 4) modules	10 (2 x 5) modules	12 (2 x 6) modules
60 or 120	265	0.795	1.06	1.325	1.59	2.12	2.65	3.18
60 or 120	270	0.81	1.08	1.35	1.62	2.16	2.70	3.24
60 or 120	275	0.825	1.10	1.375	1.65	2.20	2.75	3.30
60 or 120	280	0.84	1.12	1.40	1.68	2.24	2.80	3.36
60 or 120	285	0.855	1.14	1.425	1.71	2.28	2.85	3.42
60 or 120	290	0.87	1.16	1.45	1.74	2.32	2.90	3.48
60 or 120	295	0.885	1.18	1.475	1.77	2.36	2.95	3.54
60 or 120	300	0.90	1.20	1.50	1.80	2.40	3.00	3.60
60 or 120	305	0.915	1.22	1.525	1.83	2.44	3.05	3.66
60 or 120	310	0.93	1.24	1.55	1.86	2.48	3.1	3.72
60 or 120	315	0.945	1.26	1.575	1.89	2.52	3.15	3.78
60 or 120	320	0.96	1.28	1.6	1.92	2.56	3.2	3.84
60 or 120	325	0.975	1.3	1.625	1.95	2.6	3.25	3.9
60 or 120	330	0.99	1.32	1.65	1.98	2.64	3.3	3.96
72 or 144	310	0.93	1.24	1.55	1.86	2.48	3.10	3.72
72 or 144	315	0.945	1.26	1.575	1.89	2.52	3.15	3.78
72 or 144	320	0.96	1.28	1.60	1.92	2.56	3.20	3.84
72 or 144	325	0.975	1.30	1.625	1.95	2.60	3.25	3.90
72 or 144	330	0.99	1.32	1.65	1.98	2.64	3.30	3.96
72 or 144	335	1.005	1.34	1.675	2.0	2.68	3.35	4.02
72 or 144	340	1.02	1.36	1.70	2.0	2.72	3.40	4.0
72 or 144	345	1.035	1.38	1.725	2.0	2.76	3.45	4.1
72 or 144	350	1.05	1.40	1.75	2.0	2.80	3.50	4.2
72 or 144	355	1.065	1.42	1.775	2.0	2.84	3.55	4.2
72 or 144	360	1.08	1.44	1.8	2.0	2.88	3.6	4.3
72 or 144	365	1.095	1.46	1.825	2.0	2.92	3.65	4.3
72 or 144	370	1.11	1.48	1.85	2.0	2.96	3.7	4.4
72 or 144	375	1.125	1.5	1.875	2.0	3	3.75	4.5
72 or 144	380	1.14	1.52	1.9	2.2	3.04	3.8	4.56
72 or 144	385	1.155	1.54	1.925	2.3	3.08	3.85	4.62
72 or 144	390	1.17	1.56	1.95	2.3	3.12	3.9	4.68
72 or 144	395	1.185	1.58	1.975	2.3	3.16	3.95	4.74
72 or 144	400	1.2	1.6	2	2.4	3.2	4	4.8
72 or 144	405	1.215	1.62	2.025	2.43	3.24		4.86
72 or 144	410	1.23	1.64	2.05	2.46	3.28		4.92
72 or 144	415	1.245	1.66	2.075	2.49	3.32		4.98
72 or 144	420	1.26	1.68	2.1	2.52	3.36		5.04

No. of cells per module	Module STC power rating (W <sub>p</sub> )	Total peak power at STC in kW <sub>p</sub> for an array of X modules						
		3 modules	4 modules	5 modules	6 modules	8 (2 x 4) modules	10 (2 x 5) modules	12 (2 x 6) modules
72 or 144	425	1.275	1.7	2.125	2.55	3.4	4.25	5.1
72 or 144	430	1.29	1.72	2.15	2.58	3.44	4.4	5.2
72 or 144	435	1.305	1.74	2.175	2.61	3.48	4.45	5.3
72 or 144	440	1.32	1.76	2.2	2.64	3.52	4.5	5.4
72 or 144	445	1.335	1.78	2.225	2.67	3.56	4.55	5.46
72 or 144	450	1.35	1.8	2.25	2.7	3.6	4.6	5.5
72 or 144	455	1.365	1.82	2.275	2.73	3.64	4.65	5.55

**Examples:**

An array of **4 x 325 W<sub>p</sub> modules in series** will have a total peak power (at STC) of **1.3 kW<sub>p</sub>**.

An array of **2 parallel strings of 5 modules of 280 W<sub>p</sub> each** (10 modules of 280 W<sub>p</sub> in total) will have a total peak power (at STC) of **2.8 kW<sub>p</sub>**.

## Appendix D. PV array and geyser (water heater) element matching

It is important to match PV array specifications and heating elements for maximum power transfer efficiency. See the below table for the recommended heating element power rating for different solar array sizes.

Contact PowerOptimal for advice on module-element matching if module properties are significantly different to typical values or for advice on bifacial, high current & high voltage modules.

**TABLE D1. GUIDE: PV ARRAY AND GEYSER (WATER HEATER) ELEMENT MATCHING**

Solar PV array size (kW <sub>p</sub> )	Best matching geyser element size (kW)	2 <sup>nd</sup> choice geyser element size* (kW)	Geyser (water tank) size (litres)
1 – 1.2	4	3	100 - 200
1.2 – 1.6	3	4 or 2	100 - 200
1.6 – 2	2	3	150 – 300
2 – 4 (two parallel PV strings)	4	NA	200+

\* Second choice element size would reduce efficiency by 10 – 20%.

**DO NOT DEVIATE FROM THE RECOMMENDED MODULE-ELEMENT MATCHING CONFIGURATIONS WITHOUT CONSULTING POWEROPTIMAL.**

<b>Maximum allowed solar PV array specifications at Standard Test Conditions (STC):</b>		
<b>I<sub>sc</sub> &lt; 20A</b>	<b>V<sub>oc</sub> &lt; 240V</b>	<b>Power &lt; 4 kW<sub>p</sub></b>

## Appendix E. Technical Specification Summary: Elon® 100

Refer to the PowerOptimal website for the full Technical Specification

[www.poweroptimal.com/specifications](http://www.poweroptimal.com/specifications)

<b>Rated input voltage</b>	250V AC, 240V DC
<b>Rated input current</b>	25A AC, 20A DC
<b>Mains (AC) voltage range</b>	-50% to +100% (but will disconnect all loads when breach is greater than +/- 15%)
<b>System power supply</b>	Solar or 230V AC mains
<b>Power consumption</b>	<3W on mains power; <0.5W on solar power
<b>Shutdown</b>	Sufficient power supply capacity to manage processor, switching and data storage if both mains and solar supply fail
<b>Solar voltage (V<sub>oc</sub> at STC)</b>	20 – 240 V DC
<b>Solar energy availability</b>	Automatically determines availability of sufficient solar energy before supplying load from solar modules
<b>Controller settings</b>	Can be adjusted to run from “solar only” (100% solar energy use) to “mains only” (no solar energy use)
<b>Thermostat</b>	Uses the standard normally open thermostat switch associated with the geyser element as a sensor only, with less than 10mA sense current, to control power to the element
<b>Reverse polarity protection</b>	Protected against reverse connection of solar array
<b>Enclosure ingress protection rating</b>	Elon 100 main unit: IP65 Elon 100 remote control: IP40 (install indoors or in waterproof enclosure)
<b>Maximum distance Elon® unit to controller</b>	10 m
<b>Annual energy production compared to inverter-based system</b>	> 90% when solar array and geyser element are matched correctly
<b>Standards conformance</b>	IEC / SANS 60669, CISPR 11 & IEC 61000-6-1
<b>Dimensions &amp; weight</b>	Elon® 100 main unit: 200 x 150 x 60 mm (LxWxH), 1.75 kg. Controller: 50 x 72 x 41 mm (LxWxH)
<b>Patents</b>	ZA 2019/02129 (pending), GB2583814A (granted), PCT/IB2021/050542 (pending)

It is important to match modules and heating elements for maximum power transfer efficiency. See the tables in **Appendix D** for the recommended heating element power rating for different solar module specifications and array configurations.

## Appendix F. Surge Protection Device (SPD) Recommendations

This Appendix outlines under which circumstances a Surge Protection Device should be installed as part of a solar PV system installation such as the Elon® 100.

### E1. SANS 10142-1 The wiring of premises Part 1: Low-voltage installations

**Please note:** compliance with SANS 10142-1 is compulsory for all electrical installations as per the Occupational Health & Safety Act.

**SANS 10142-1 states the following with regards to surge protection:**

#### 6.7.6 Surge protection

6.7.6.1 Surge protective devices (SPDs) **may be installed** to protect an installation against transient overvoltages and surge currents such as those due to switching operations or those induced by atmospheric discharges (lightning). *NOTE* A risk assessment may be performed in accordance with annex Q. The Installation of SPDs is necessary where structures are equipped with external lightning protection systems (LPS) as in accordance with SANS 10313.

As can be seen above, surge protection is optional and based on a risk assessment as per Annex Q.

The risk assessment is as per the following table from SANS 10142-1 (2020):

**Table Q.1.1 — Surge Protection Requirements for residential Buildings**

Surge protection requirements for RESIDENTIAL buildings									
Lightning Flash Density (Ng)	RURAL ENVIRONMENT			SUBURBAN ENVIRONMENT			URBAN ENVIRONMENT		
	Service Line (l)	Type of SPD Required		Service Line (l)	Type of SPD Required		Service Line (l)	Type of SPD Required	
$0 \leq Ng < 3$	> 62 m	T2	5 kA	> 85 m	T2	5 kA	> 425 m	T2	5 kA
$3 \leq Ng < 7$	> 26 m	T2	5 kA	> 36 m	T2	5 kA	> 182 m	T2	5 kA
$7 \leq Ng < 11$	> 17 m	T2	20 kA	> 23 m	T2	20 kA	> 115 m	T2	20 kA
$Ng \geq 11$	> 13 m	T2	20 kA	> 17 m	T2	20 kA	> 85 m	T2	20 kA

Note that the “Service Line” referred to above is the incoming (AC) line for the house.

Here is a lightning density map for South Africa as provided in SANS 10142-1:

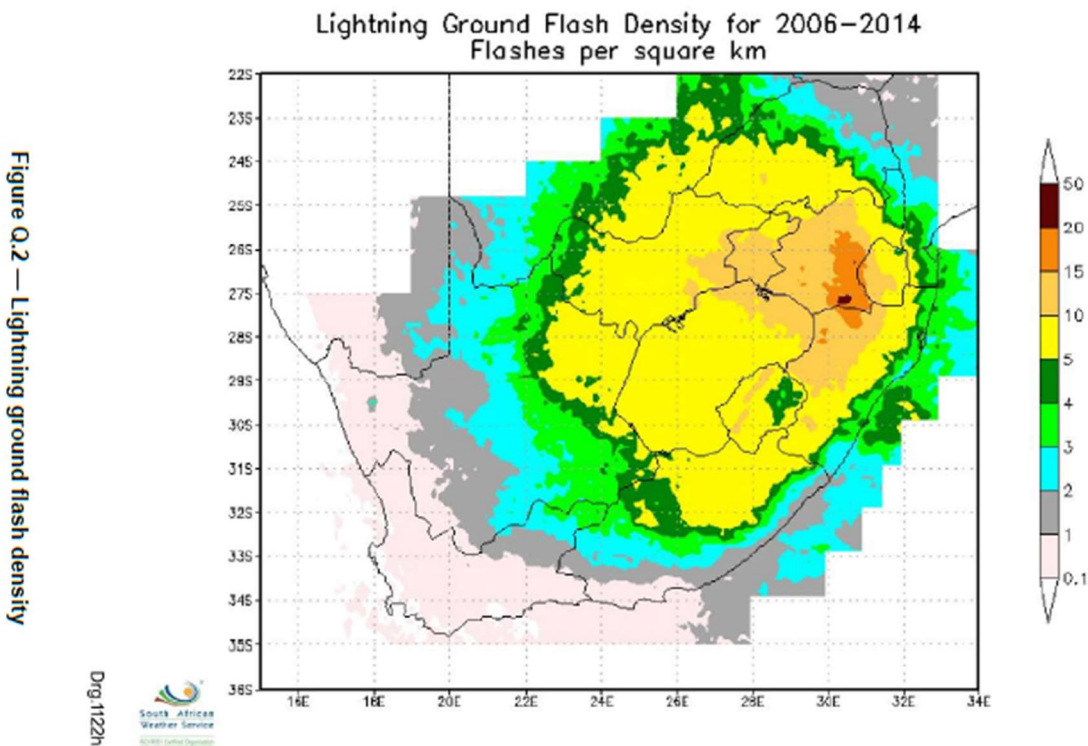

## E2. Draft standard SANS 10142-3 Proposed Interim Guideline for the wiring of LV grid-embedded PV installations not exceeding 1000kVA in South Africa

**Please note:** this is only a draft standard and compliance with this standard is **not** compulsory. It is only provided for information purposes.

The draft standard SANS 10142-3 requires a Surge Protection Device to be installed where the length (**L**) of the DC cables (from PV array to Elon® 100 or inverter) exceeds the critical length **L<sub>crit</sub>** as follows:

A Surge Protection Device is required where  **$L \geq L_{crit}$**

The critical length **L<sub>crit</sub>** depends on the type of PV installation and is calculated according to the following table:

Type of installation	Individual residential premises	Terrestrial production plant	Service / Industrial / Agricultural Buildings
L <sub>crit</sub> (in meter)	115/Ng	200/Ng	450/Ng

where Ng = lightning strike density (number of strikes/km<sup>2</sup>/yr)

The length of DC cables **L** is the **sum** of:

- distances between the inverter(s) and the junction box(es), while observing that the lengths of cable located in the same conduit are counted only once, and
- distances between the junction box and the connection points of the photovoltaic modules forming the string, observing that the lengths of cable located in the same conduit are counted only once.

For the Elon® 100, distance **L** is the length of DC cables from PV array to the Elon® 100.

On the next page is a national lightning ground stroke density map for South Africa<sup>5</sup>.

From this map, the lightning strike density (Ng) range for major cities are as follows:

City	Lightning strike density Ng (strikes/km <sup>2</sup> /yr)	Lcrit (m)	
		Individual residential premises	Service / industrial / agricultural buildings
Cape Town	0.02 to 4	29	113
Stellenbosch	0.02 to 4	29	113
Worcester	0.02 to 4	29	113
George	0.02 to 4	29	113
Saldanha	0.02 to 4	29	113
Port Elizabeth	0.02 to 4	29	113
East London	4 to 6	19	75
King Williams Town	4 to 6	19	75
Beaufort-West	4 to 6	19	75
Musina	4 to 6	19	75
Britstown	6 to 15	8	30
Durban	6 to 15	8	30
Upington	6 to 15	8	30
Pietermaritzburg	15 to 21	5	21
Greytown	15 to 21	5	21
Polokwane	15 to 21	5	21
Bloemfontein	15 to 21	5	21
Queenstown	15 to 21	5	21
Vryburg	15 to 21	5	21
Mahikeng	15 to 21	5	21
Mbombela (Nelspruit)	15 to 21	5	21
Kimberley	21 to 27	4	16
Pretoria	21 to 27	4	16
Vereeniging	21 to 27	4	16
Welkom	21 to 27	4	16
Johannesburg	27 to 33	3.5	13
Ermelo	33 to 42	2.5	10
Newcastle	33 to 42	2.5	10

<sup>5</sup> Evert CR, Gijben M. 2017. Official South African Lightning Ground Flash Density Map 2006 to 2017.



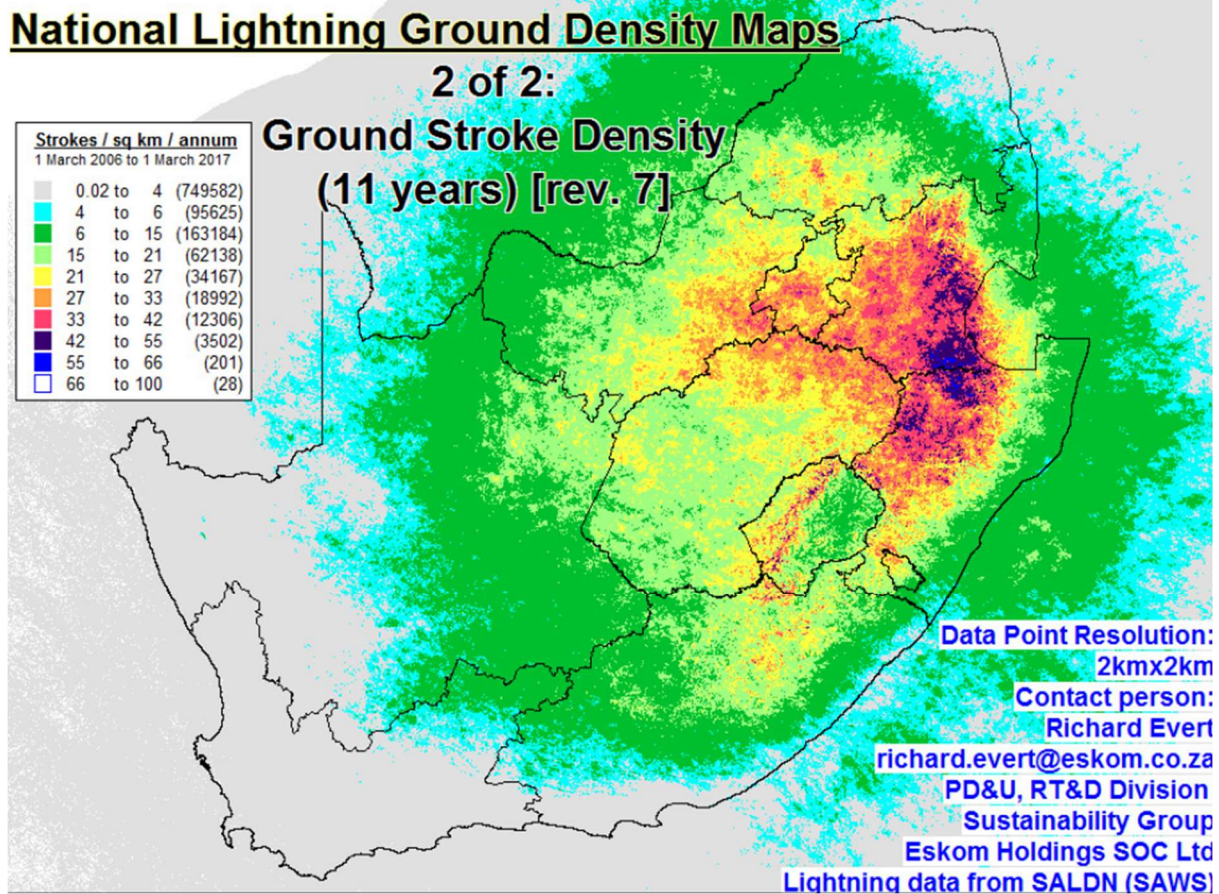

From Evert & Gijben (2017).

## Appendix G. IEC/SANS and EMC Test Certificates: Elon® 100



**TEST Africa**

WCT (PTY) LTD T/A T.E.S.T. Africa  
reg #: 2000/024600/07  
vat reg #: 4620192684

Room S166, Building 33 PO Box 36335  
CSIR Grounds Scientia, Menlopark  
Pretoria 0135 Pretoria, 0102  
South Africa

Tel.: (+27 12) 349 1145  
Fax.: (+27 12) 349 1249  
E-mail: info@testafrica.co.za  
Internet:  
<http://www.testafrica.co.za>



T01-46



### Test Report

IEC 60669-2-1:2015

Particular requirements – Electronic Switches  
Switches for household and similar fixed-electrical installations

REPORT # : WCT 24/0529

**CLIENT:**

Power Optimal (Pty) Ltd  
Postnet Suite 21, Private Bag X21  
Tyger Valley, Bellville  
7536

Attention: Mr J Theron  
Order #: Application form  
Date of Order: 9 April 2024

**SAMPLE:**

AC/ DC Controller

**TEST SPECIFICATION:**

IEC 60669-1:2017/ SANS 60669-1:2017  
IEC 60669-2-1:2015/ SANS 60669-2-1:2015

**SUMMARY OF RESULTS:**

Complied

**DATE STARTED:**

2024-05-09

**DATE COMPLETED:**

2024-05-27

**DATE OF ISSUE:**

2024-05-27

**TESTED &  
APPROVED:**

  
G.H. Holtzhausen (Technical Signatory)

**REVIEWED:**

  
P.P. Kuisis (Test Engineer)

NOTE: This report relates only to the specific sample(s) tested as identified herein. The test results do not apply to any similar items that has not been tested.

Page 1 of 44

Elon 100 - 7932/19

Report Number: 7932/19 Rev 1.0 Date Printed: 02/08/2019

Page: 1 of 24



### Interference Testing And Consultancy Services (Pty) Ltd

ITC SERVICES (PTY) LTD  
Registration number: 88/002032/07  
Plot 44 Kameeldrift East, Pretoria  
Private Bag X13 Lynn East, 0039  
Republic of South Africa

Tel: +27 (0) 12 808 1730  
Fax: +27 (0)12 808 1733

## EMC TEST REPORT

TEST METHOD / STANDARD : CISPR 11 & IEC 61000-6-1  
CLIENT / APPLICANT : Power Optimal (Pty) Ltd  
DEVICE TESTED : Elon 100

REPORT NUMBER : R 7932/19  
REVISION : 1.0  
DATE ISSUED : 27/06/2019  
COPY : Master

#### CONFIGURATION CONTROL

ORIGINAL ONLY  
IF THIS NOTE  
IS IN RED INK

This test report was prepared by : **Name:** S Joubert  
**Title:** EMC Engineer

This test report was reviewed by : **Name:** C Fouche  
**Title:** Technical Director



This EMC test Report may only be reproduced in full with the written approval of ITC Services (Pty) Ltd.

Elon 100 - 7932/19

Report Number:  
7932/19

Rev 1.0

Date Printed: 02/08/2019

Page: 24 of 24

## 12. CONCLUSION

The Elon 100 version V2 with serial number: 19283 meets the requirements of the following specifications called for in CISPR 11 & IEC 61000-6-1:

### 12.1 APPLIED TEST METHOD / STANDARDS

#### 12.1.1 SANS / CISPR

- CISPR 11 (2016-06 ED.6.1): *'Industrial, scientific and medical equipment – Radio-frequency disturbance characteristics – Limits and methods of measurement'*

#### 12.1.2 SANS / IEC

- SANS 61000-4-2 (2009) / IEC 61000-4-2 (2008): *Testing and measurement techniques – Electrostatic discharge immunity test*
- SANS 61000-4-3 (2008) / IEC 61000-4-3 (2010): *Testing and measurement techniques – Radiated, radio-frequency, electromagnetic field immunity test*
- SANS 61000-4-4 (2011) / IEC 61000-4-4 (2011): *Testing and measurement techniques – Electrical Fast Transient / Burst*
- SANS 61000-4-5 (2006) / IEC 61000-4-5 (2005): *Testing and measurement techniques – Surge immunity test*
- SANS 61000-4-6 (2009) / IEC 61000-4-6 (2008): *Testing and measurement techniques – Immunity to conducted disturbances, induced by radio-frequency fields*
- SANS 61000-4-11 (2005) / IEC 61000-4-11(2004): *Testing and measurement techniques – Voltage Dips, Short Interruptions and voltage variations immunity test.*

## 13. COMPLIANCE STATEMENT

The EUT complies with the requirements of the specifications listed in 12.1 above.
--

————— END OF REPORT —————



WCT (PTY) LTD T/A T.E.S.T. Africa  
reg #: 2000/024600/07  
vat reg #: 4620192684

Room S166, Building 33 PO Box 36335  
CSIR Grounds Menlopark  
Brummeria Pretoria, 0102  
Pretoria South Africa

Tel.: (+27 12) 349 1145

Fax.: (+27 12) 3491249

E-mail: [info@testafrica.co.za](mailto:info@testafrica.co.za)

Internet: <http://www.testafrica.co.za>



# Test Report

SANS 60335-2-21:2000

Safety of household and similar electrical appliances  
Part 2: Particular requirements for storage water heaters

REPORT #: WCT 24/0033

CLIENT:

Electrolux SA (Pty) Ltd  
P.O. Box 389  
Benoni  
1500

Attention: Ughard de Clercq  
Order #: MNF07poh000014532  
Date of Order: 2024-01-12

SAMPLE:

ELON 100 CONNECTED TO A 150 L GEYSER

TEST SPECIFICATION:

SABS IEC 60335-1:1991 SABS 60335-2-21:2000

SUMMARY OF RESULTS:

Complied

DATE STARTED:

2024-01-00

DATE COMPLETED:

2024-02-16

DATE OF ISSUE:

2024-02-16

TESTED:

  
KJ Anderson (Test engineer)

APPROVED:

  
LP Kuisis (Technical Signatory)

NOTE: This report relates only to the specific sample(s) tested as identified herein. The test results do not apply to any similar item that has not been tested. **Page 1 of 41**

## Appendix H. Warranty

If the PowerOptimal Elon® 100 (“the Product”) is found to be defective, you will be entitled to a repair or replacement within 2 (two) year of the date of delivery of the Product to you. **Please keep your receipt as proof of purchase.** If you are a consumer as defined in the Consumer Protection Act No. 68 of 2008 (“the CPA”), you will be entitled to such remedies as are made available under the CPA in relation to the return of goods.

PowerOptimal will not have any liability or obligation to you where the Product has been subjected to abuse, misuse, improper use, improper testing, negligence, accident, alteration, tampering or repair by a third party.

To the maximum extent permitted by applicable law, in no event shall PowerOptimal be liable for any special, incidental, indirect, or consequential damages whatsoever, including, without limitation, damages for loss of business profits or business interruption, arising out of the use or inability to use this product.

**Please note that this unit must be installed by an electrical contractor registered with the Department of Labour.** Failure to do so may invalidate this warranty. Please keep the CoC (Certificate of Compliance) issued by the electrical contractor on completion of the installation.

## Appendix I. Terminology

AC	Alternating Current – an electric current that reverses its direction many times a second at regular intervals, with voltage typically varying in the form of a sine wave.
CoC	Certificate of Compliance – to be issued by the electrician installing your Elon® 100 system
CPA	Consumer Protection Act No. 68 of 2008
DB	Distribution board – the main electrical distribution board / panel in your home, containing circuit breakers and switches.
DC	Direct Current – an electric current flowing in one direction only. Solar PV modules produce direct current electricity.
Geyser	South African term for a water heater
IEC	International Electrotechnical Commission
$I_{mpp}$	The solar module current at maximum power point (MPP). Manufacturers usually report two $I_{mpp}$ values: one at STC and one at NOCT.
kWh	A derived unit of energy equal to 3.6 MJ (megajoules). The amount of energy used by a 1 kW electrical device over a period of 1 hour.
$kW_p$ or $W_p$	The peak power rating in kilowatt (kW) or watt (W) of a solar module or array – i.e. the output power achieved under full solar radiation. This is usually reported at STC and NOCT.
MPP	Maximum power point. This is the point on a solar cell, module or array's power or I-V (current-voltage) curve that has the highest power output.
NOCT	Nominal Operating Cell Temperature (also sometimes referred to as NMOT or Nominal Module Operating Temperature). This refers to the temperature that open circuited solar PV modules will reach under conditions that more closely match actual field operational conditions than STC. The modules are tested at 800 W/m <sup>2</sup> simulated solar irradiance, 20 °C ambient temperature, 1 m/s wind velocity and open back side mounting. Depending on the quality of the cell / module design, the NOCT can reach anything from 33 to 58 °C <sup>6</sup> . Since solar PV cell power output reduces with increase in temperature, a lower NOCT is better.
PV	Photovoltaic – referring to the production of electric current at the junction of two materials exposed to light.
SANS	South African National Standards
STC	Standard Test Conditions for solar cells – 1000 W/m <sup>2</sup> simulated solar irradiance and 25 °C solar cell temperature, and an air mass 1.5 spectrum (AM1.5).
$V_{mpp}$	The solar module voltage at maximum power point (MPP). Manufacturers usually report two $V_{mpp}$ values: one at STC and one at NOCT.

---

<sup>6</sup> Source: <http://pveducation.org/pvcdrom/modules/nominal-operating-cell-temperature>.

